

DATA SHEET

U 5.101 O₂-PACK ROTARY VANE- VACUUM PUMPS

oil-lubricated
air-cooled

MAKE IT BECKER.

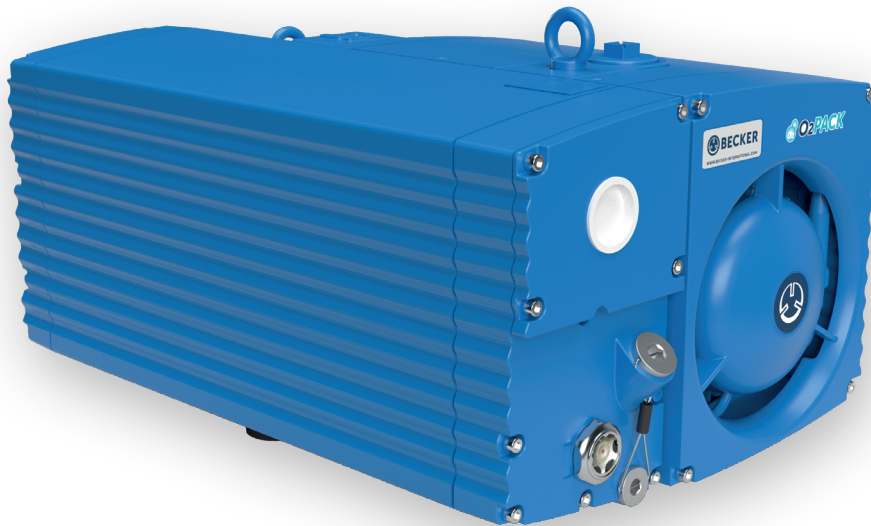

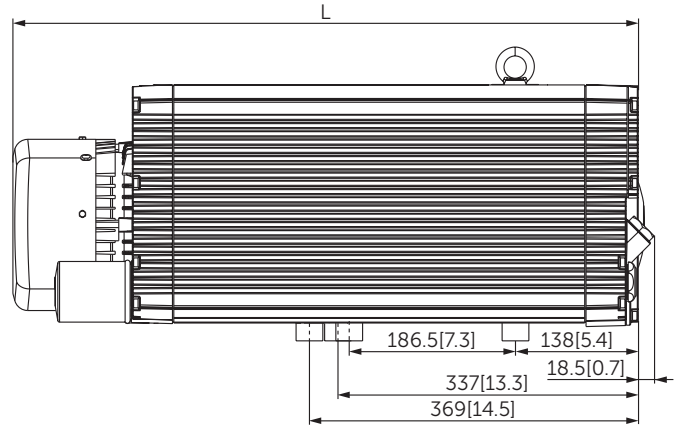
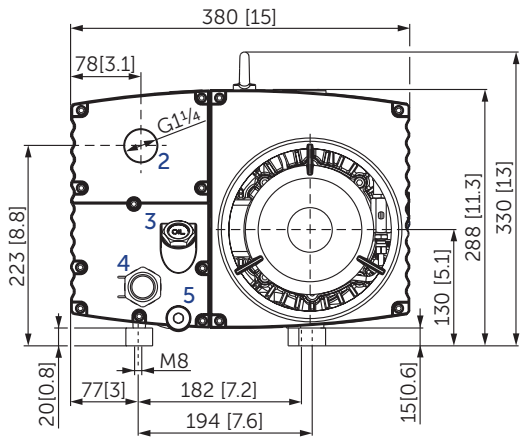

- 1 Vacuum connection (G1¼)
- 2 Exhaust air connection (G1¼)
- 3 Oil filler cap (G¾)
- 4 Oil sight glas (G1)
- 5 Screw plug for oil drain (G½)
- 6 Rubber buffer position
 - incl. gas ballast valve, non-return valve, oil separator and oil filter
 - The motor illustration may vary
 - Dimensions in mm [inch]

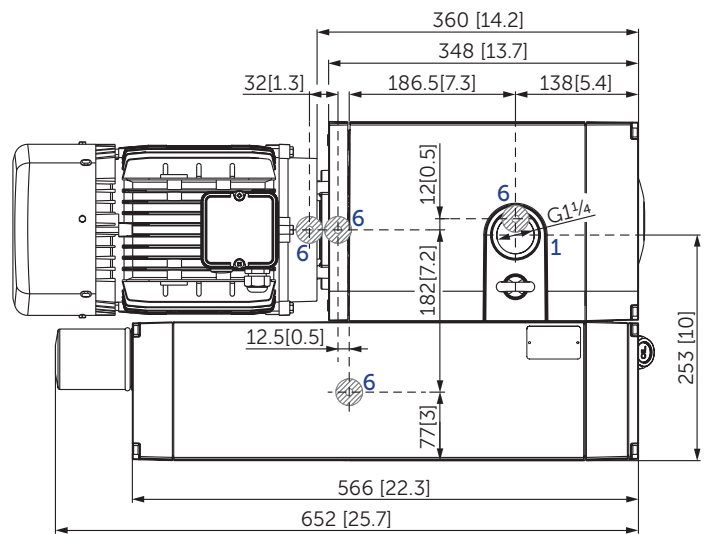

Nominal capacity		Vacuum absolute for continous operation		Emission sound pressure level ¹⁾		Weight w/o motor	Oil Fomblin® YL VAC 25/6
m³/h		mbar		dB(A)		kg	l
50 Hz	60 Hz	50 Hz	60 Hz	50 Hz	60 Hz		
100	120	<0.5–400	<0.5–400	65	68	48	2 (≈3.8 kg)

¹⁾ According to DIN EN ISO 11203, accuracy class of measurement: class 2, extended measurement uncertainty: 3 dB
1 m [39.4 inch] distance, at medium load, both connection sides piped

▪ Gas ballast valve: water vapour tolerance max. 7 mbar; water vapour capacity max. 0.45 l/h (at 85°C operating temperature)

3~ Motors											L
#	50 Hz				60 Hz				Version	Weight kg	mm [inch]
	kW	V	min ⁻¹	A	kW	V	min ⁻¹	A			
01	Δ230/Y400 IE3 1460 7.45/4.3								CC055B NEMA Premium UL(E68554) CSA IP55 ISO F PTC	29.0	706 [27.8]
	2.2	Y380	IE3	1454 4.5	2.2	Y460	IE3	1766 3.8			
	Y415 IE3 1464 4.3										
					2.64	Δ208		1740 9.7			
						Δ230		1752 8.7			
					Y400		1752 5.0				
					Y460		1758 4.4				
02					2.6	YY230/Y460	IE3	1765 9.3/4.6	UL(E365362) • CSA CC334B	37.0	741 [29.2]
					YY208		1755 9.7	IP55 • ISO F • bimetal			
03	2.2	Δ200/Y350	IE3	1460 11.2/6.5	2.6	Δ220/Y380-400	IE3	1750 10.6/6.1-5.8	UL(E365362) • CSA IP55 • ISO F • bimetal	29.0	728 [28.7]
					Δ200/Y350		1740 10.8/6.2				
04					2.6	Δ400/Y690	IE3	1760 5.25/3.03	UL(E365362) • CSA IP55 • ISO F • bimetal	37.0	741 [29.2]

• Current consumption and rotation speed may vary. Tolerance in each case -1.5/+2%

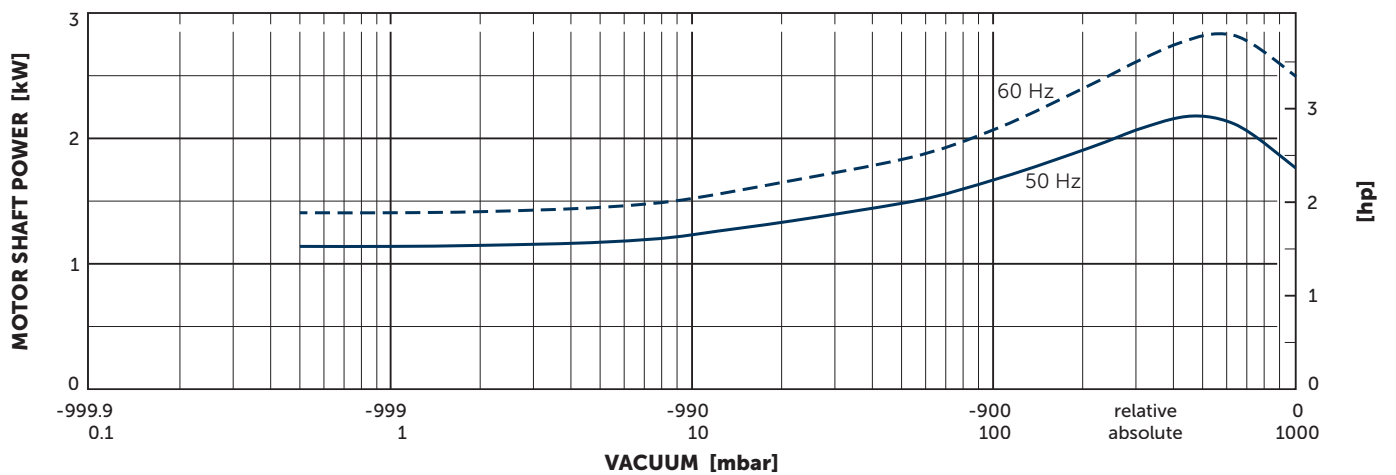
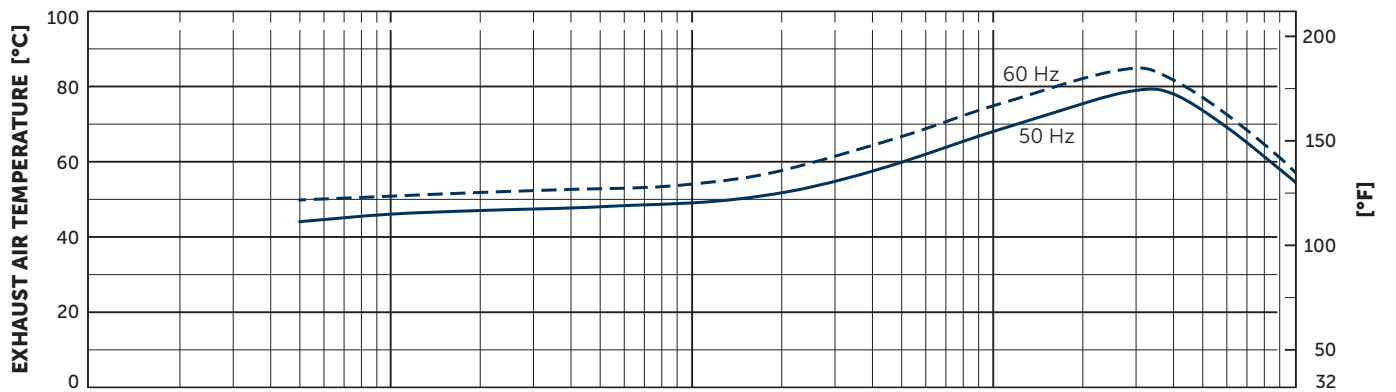
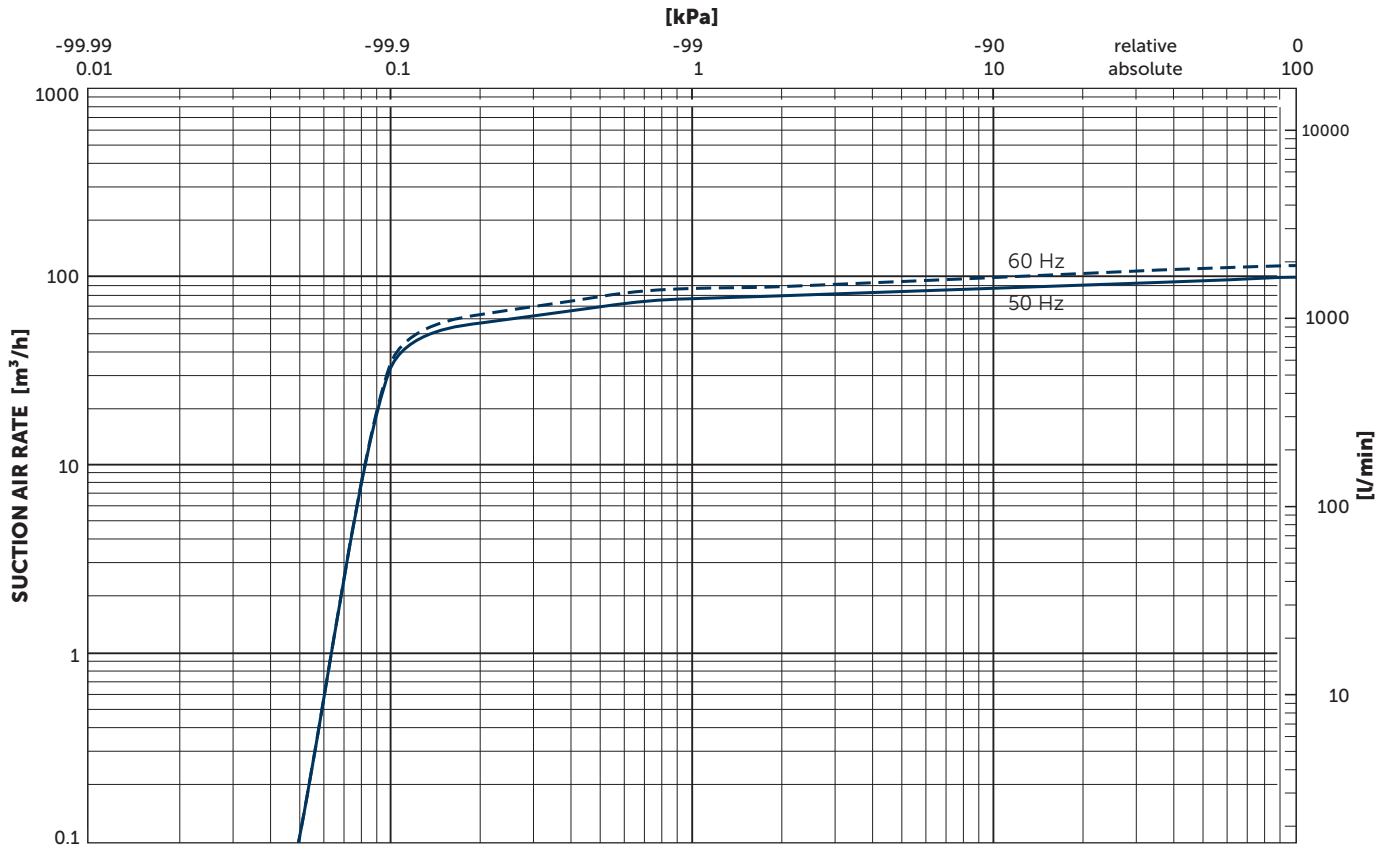

Suction air rate refers to the intake pressure
 Reference data (atmosphere): 1000 mbar (100 kPa), 20°C (68°F)
 Tolerance: ±10%



MAKE IT BECKER.