

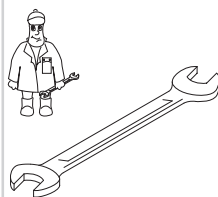

Gebr. Becker GmbH & Co.KG
Hölker Feld 29-31
D-42279 Wuppertal

Wartung
Maintenance
Entretien
Manutenzione
Mantenimiento



	Pos.	Menge ²⁾ Quantity Quantité Quantità Cantidad	Bestell-Nr. Ident No. No. Identification No. Identificazione No. de pedido	Bezeichnung Description Designation Designazione Descripción
U 4.400	□	1	549000 26700	Dichtungssatz, Complete set of seals, Jeu de joints, Kit di guarnizioni, Junta completa
	6	SATZ (KIT)	900580 00003	Schieber, Rotor vane, Palette, Silenciador
	89	2	965410 00000	Luftentölelement, Oil separating element, Element separation huile, Cartuccia separatore olio, Elemento de desaceitar de aire
	94	3	506000 12900	Grobabscheider, Coarse separator, Separateur a gros, Separatore grossolano, Separador de solidos gruesos

²⁾ erforderliche Bestellmenge / necessary order quantity / quantité nécessaire / quantità di ordinazione necessari / cantidad necesario



Ersatzteilliste
Spare parts list
Liste de pièces de rechange
Listino pezzi di ricambio
Lista de piezas de recambio
Lista de peças sobresselentes
Reserveonderdelenlijst
Reservedelsliste
Reservdelslista

Reservedelsliste
Varaosaluettelo
Wykaz części zamiennych
Seznam náhradních dílů
Tartalékalkatrész lista
Κατάλογος ανταλλακτικών
Перечень запасных частей
备用零件目录
スペアパーツリスト

U 4.400



28007800000 06/2010

Index-A

SERVICE

Made in Germany

BECKER Baujahr/year XXXX

D-42279 Wuppertal No. **A**

Typ **U 4.400-XX**

Drehzahl / speed XXXX min⁻¹

Leistungsbedarf motor power required XXXX kW

Saugvermögen inlet capacity XXXX m³/h

Saugdruck / vacuum XXXX mbar

Index Option

D Service:

Tel: +49 (0)202 697-171

Fax: +49 (0)202 64 44 74

E-Mail: info@becker-international.com

www.becker-international.com



U 4.400

Pos.	Bestell Nr.	Beschreibung	
□	549000 26700	DICHTUNGSSATZ ¹⁾	
2	000100 26600	GEHÄUSE	
3	020000 26600	KOLBEN	
4	951212 00000	VERSCHLUSS-SCHRAUBE	
6	900580 00003	KUNSTSTOFFSCHIEBER (SATZ)	
7	030703 26600	SCHIEBE	
8	906617 50000	WÄLZLAGER	
9	906600 00700	INNENRING	
10	906600 00800	INNENRING	
11	945331 00000	INNENSECHSKANTSCHRAUBE	
12	948209 00000	SEEGER-RING	
14	906595 00000	WELLENDICHTRING	
17	912871 00000	VERSCHLUSS-SCHRAUBE	
18	000800 26600	SEITENDECKEL	
19	000700 26600	SEITENDECKEL	
20	951211 00000	VERSCHLUSS-SCHRAUBE	
21	948744 00000	KERBSTIFT	
22	945390 00000	INNENSECHSKANTSCHRAUBE	
24	005600 26600	DECKEL	
29	029100 26600	VENTILTRÄGER	
30	033904 26600	VENTILPLATTE	
33	928603 10000	DRUCKFEDER	
34	007800 26600	GEWINDEFLANSCH	
35	948225 00000	SICHERUNGSRING	
36	008000 26600	SIEB	
37	945351 00000	INNENSECHSKANTSCHRAUBE	
38	946967 00000	STIFTSCHRAUBE	
39	003700 26600	DECKEL	
42	947410 00000	HUTMUTTER	
43	951604 00000	RINGMUTTER	
44	947514 00000	U-SCHIEBE	
72	002400 26600	ÖLABSCHEIDERGEHÄUSE	
74	022800 26600	FILTERTRÄGER	
76	951049 02000	STIFTSCHRAUBE	
77	033901 26600	VENTILPLATTE	
78	030700 26600	VENTILSCHIEBE	
79	917551 04000	PASS-SCHIEBE	
80	948128 04000	SEEGERRING	
81	928602 80000	DRUCKFEDER	
82	950185 00000	KLEMMSCHEIBE	
83	005603 26600	DECKEL	
84	945637 00000	GEWINDESTIFT	
85	068005 26600	DISTANZSTÜCK	
89	965410 00000	LUFTENTÖLELEMENT (2x) ²⁾	
90	068008 26600	DISTANZSTÜCK	
92	951041 02000	STIFTSCHRAUBE	
94	506000 12900	GROBABSCHIEDER (3x) ²⁾	
95	030701 10700	SCHIEBE	
97	947402 00000	HUTMUTTER	
100	002504 26600	ÖLABSCHEIDERDECKEL	
102	945391 00000	INNENSECHSKANTSCHRAUBE	
103	945392 00000	INNENSECHSKANTSCHRAUBE	
105	002500 26600	ÖLABSCHEIDERDECKEL	
107	945353 00000	INNENSECHSKANTSCHRAUBE	
108	945350 00000	INNENSECHSKANTSCHRAUBE	
110	008003 26600	SIEB	
112	867800 99559	SCHWIMMER	
113	912300 00000	ANSCHLUSS-SCHRAUBE	
115	003300 10700	DÜSE	
117	002501 26600	ÖLABSCHEIDERDECKEL	
122	907309 00000	ÖLSCHAUGLAS	
123	951220 00100	VERSCHLUSS-SCHRAUBE	
126	916800 10000	SCHRAUBDECKEL	
131	946945 00000	STIFTSCHRAUBE	
133	951221 00100	VERSCHLUSS-SCHRAUBE	
137	064600 26600	FILTERMATTE	
138	008002 26600	SIEB	
144	068006 26600	DISTANZSTÜCK	
145	948215 00000	SEEGER-RING	
146	928603 30000	DRUCKFEDER	
151	502301 26600	KUPPLUNGSHÄLFTE MIT VENTILATOR	
175	948401 00000	HOHLSCHRAUBE	



U 4.400

Pos.	Bestell Nr.	Beschreibung	
176	048400 26600	HOHLSCHRAUBE	
177	945224 00000	SECHSKANTSCHRAUBE	
178	030701 26600	VENTILSCHIEBE	
179	030702 26600	VENTILSCHIEBE	
180	016801 26600	SPANNSCHEIBE	
182	928603 20000	DRUCKFEDER	
183	016800 26600	SPANNSCHEIBE	
184	028500 26600	VENTILBOLZEN	
186	947104 00000	SECHSKANTMUTTER	
187	013300 26600	PRALLBLECH	
188	945330 00000	INNENSECHSKANTSCHRAUBE	
189	947506 00000	UNTERLEGSCHEIBE	
192	947107 00000	SECHSKANTMUTTER	
194	948516 00000	FEDERRING	
197	947820 00000	PASSFEDER	
198	062900 26600	SCHIEBE	
202	053200 26600	LATERNE	
203	945388 00000	INNENSECHSKANTSCHRAUBE	
204	947515 00000	U-SCHIEBE	
205	948511 00000	FEDERRING	
208	003702 26600	DECKEL	
211	003701 26600	DECKEL	
212	945333 00000	INNENSECHSKANTSCHRAUBE	
215	741341 00000	GUMMIPUFFER	
216	945633 00000	GEWINDESTIFT	
217	068001 26600	DISTANZSTÜCK	
218	946811 00000	STIFTSCHRAUBE	
222	560200 26600	KÜHLER KOMPLETT	
223	945349 00000	INNENSECHSKANTSCHRAUBE	
224	951710 00000	FEDERSCHIEBE	
227	902102 26600	MOTORKUPPLUNG	
228	902227 00000	KUPPLUNGSSCHIEBE	
229	068004 26600	DISTANZSTÜCK	
231	946962 00000	STIFTSCHRAUBE	
233	947109 00000	SECHSKANTMUTTER	
234	947509 00000	U-SCHIEBE	
236	961710 00000	WINKEL	
237	972308 00000	ERMETO-VERSCHRAUBUNG	
238	512204 26600	LEITUNG	
239	512200 26600	ÖLRÜCKFÜHRLEITUNG	
241	012204 26700	LEITUNG	
243	761703 01000	ERMETO-VERSCHRAUBUNG	
244	012206 26600	LEITUNG	
245	012207 26600	LEITUNG	
247	961709 00000	WINKEL	
248	064101 57000	PROFILGUMMI	
251	009400 19000	KUGELSTÜCKSCHRAUBE	
255	518300 26600	HAUBE	
256	945389 00000	INNENSECHSKANTSCHRAUBE	
290	060900 26600	DÄMPFUNGSMATTE	
291	943400 90000	TEMPERATURFÜHLER	

¹⁾ Dichtungssatz - 549000 26700

- Pos.: 15, 16, 25, 31, 32, 40, 73, 87, 88, 101, 106, 109, 118, 124, 127, 141, 185, 191, 252, 254

²⁾ erforderliche Bestellmenge / Wartung

OPTIONAL

- U 4.400 SA/K -25 Sonderausführung - mit Öl-Wasser-Kühler
- U 4.400 SA/K -51 Sonderausführung - mit Ölbadheizung, Niveau-Geber und Thermostat
- U 4.400 F/K -25 Sonderausführung - mit Öl-Wasser-Kühler
- U 4.400 F/K -51 Sonderausführung - mit Ölbadheizung, Niveau-Geber und Thermostat
- U 4.400 USA alle Ausführungen

Abweichende Positionen zum Standardgerät - siehe Anhang (Zeichnungsrückseite)





U 4.400

Pos.	Ident No.	Description
□	549000 26700	COMPLETE SET OF SEALS ¹⁾
2	000100 26600	PUMP BODY
3	020000 26600	ROTOR
4	951212 00000	SCREWED SEALING PLUG
6	900580 00003	PLASTIC VANES (KIT)
7	030703 26600	WASHER
8	906617 50000	BEARING
9	906600 00700	INTERIOR RING
10	906600 00800	INTERIOR RING
11	945331 00000	SOCKET HEAD SCREW
12	948209 00000	SEEGER-LOCKRING
14	906595 00000	SHAFT SEALING RING
17	912871 00000	LOCKING SCREW
18	000800 26600	LID
19	000700 26600	LID
20	951211 00000	LOCKING SCREW
21	948744 00000	GROOVED PIN
22	945390 00000	SOCKET HEAD SCREW
24	005600 26600	COVER
29	029100 26600	VALVE SUPPORT
30	033904 26600	VALVE PLATE
33	928603 10000	PRESSURE SPRING
34	007800 26600	FLANGE
35	948225 00000	LOCKING RING
36	008000 26600	SIEVE
37	945351 00000	SOCKET HEAD SCREW
38	946967 00000	STUD
39	003700 26600	COVER
42	947410 00000	CAP NUT
43	951604 00000	RING UNIT
44	947514 00000	WASHER
72	002400 26600	HOUSING FOR OIL SEPARATION
74	022800 26600	FILTER HOLDER
76	951049 02000	STUD
77	033901 26600	VALVE PLATE
78	030700 26600	VALVE WASHER
79	917551 04000	DISTANCE DISC
80	948128 04000	SEEGER LOCKRING
81	928602 80000	PRESSURE SPRING
82	950185 00000	SEEGER-LOCKRING
83	005603 26600	COVER
84	945637 00000	THREADED PIN
85	068005 26600	SPACER BLOCK
89	965410 00000	OIL SEPARATION ELEMENT (2x) ²⁾
90	068008 26600	SPACER BLOCK
92	951041 02000	STUD
94	506000 12900	COARSE SEPARATOR (3x) ²⁾
95	030701 10700	WASHER
97	947402 00000	CAP NUT
100	002504 26600	OIL SEPARATOR COVER
102	945391 00000	SOCKET HEAD SCREW
103	945392 00000	SOCKET HEAD SCREW
105	002500 26600	OIL SEPARATOR COVER
107	945353 00000	SOCKET HEAD SCREW
108	945350 00000	SOCKET HEAD SCREW
110	008003 26600	SIEVE
112	867800 99559	FLOAT
113	912300 00000	CONNECTING SCREW
115	003300 10700	NOZZLE
117	002501 26600	OIL SEPARATOR COVER
122	907309 00000	OIL SIGHT GLASS
123	951220 00100	LOCKING SCREW
126	916800 10000	COVER
131	946945 00000	STUD
133	951221 00100	LOCKING SCREW
137	064600 26600	FILTER INSERT
138	008002 26600	SIEVE
144	068006 26600	SPACER BLOCK
145	948215 00000	SEEGER-LOCKRING
146	928603 30000	PRESSURE SPRING
151	502301 26600	COUPLING WITH FAN
175	948401 00000	HOLLOW SCREW



U 4.400

Pos.	Ident No.	Description
176	048400 26600	HOLLOW SCREW
177	945224 00000	HEX-HEAD SCREW
178	030701 26600	VALVE WASHER
179	030702 26600	VALVE WASHER
180	016801 26600	CLAMPING DISC
182	928603 20000	PRESSURE SPRING
183	016800 26600	CLAMPING DISC
184	028500 26600	VALVE BOLT
186	947104 00000	HEX.NUT
187	013300 26600	METAL FILTER
188	945330 00000	SOCKET HEAD SCREW
189	947506 00000	WASHER
192	947107 00000	HEX. NUT
194	948516 00000	SPRING WASHER
197	947820 00000	KEY
198	062900 26600	WASHER
202	053200 26600	CONNECTION FLANGE
203	945388 00000	SOCKET HEAD SCREW
204	947515 00000	WASHER
205	948511 00000	SPRING WASHER
208	003702 26600	COVER
211	003701 26600	COVER
212	945333 00000	SOCKET HEAD SCREW
215	741341 00000	RUBBER BUFFER
216	945633 00000	THREADED PIN
217	068001 26600	SPACING COLLAR
218	946811 00000	STUD
222	560200 26600	COOLER
223	945349 00000	SOCKET HEAD SCREW
224	951710 00000	SPRING DISC
227	902102 26600	COUPLING MOTOR SIDE
228	902227 00000	COUPLING DISC
229	068004 26600	SPACER BLOCK
231	946962 00000	STUD
233	947109 00000	HEX. NUT
234	947509 00000	WASHER
236	961710 00000	ELBOW
237	972308 00000	THREADED JOINT
238	512204 26600	OIL PIPE
239	512200 26600	OIL RETURN PIPE
241	012204 26700	PIPE
243	761703 01000	THREADED JOINT
244	012206 26600	PIPE
245	012207 26600	PIPE
247	961709 00000	ELBOW
248	064101 57000	RUBBER PROFIL
251	009400 19000	HOLLOW HOLDING SCREW
255	518300 26600	PROTECTING HOOD
256	945389 00000	SOCKET HEAD SCREW
290	060900 26600	SILENCER
291	943400 90000	TEMPERATURE PROBE



¹⁾ Set of seals - 549000 26700
- Pos.: 15, 16, 25, 31, 32, 40, 73, 87, 88, 101, 106, 109, 118, 124, 127, 135, 141, 185, 191, 242, 246, 252, 254
²⁾ necessary order quantity / maintenance

OPTIONAL

U 4.400 SA/K	-25	Special design – with oil-to-water heat exchanger
U 4.400 SA/K	-51	Special design – with oil bath heating, level transmitter and heat valve
U 4.400 F/K	-25	Special design – with oil-to-water heat exchanger
U 4.400 F/K	-51	Special design – with oil bath heating, level transmitter and heat valve
U 4.400	USA	all types

Items different from standard appliance see appendix (back of drawing)



U 4.400

Pos.	No. Identification	Designation
□	549000 26700	JEU COMPLET DE JOINTS ¹⁾
2	000100 26600	CARCASSE
3	020000 26600	PISTON
4	951212 00000	VIS DE FERMETURE
6	900580 00003	PALETTE ON PLASTIQUE (KIT)
7	030703 26600	RONDELLE
8	906617 50000	ROULEMENT
9	906600 00700	BAGUE INTERIEURE
10	906600 00800	BAGUE INTERIEURE
11	945331 00000	VIS HEXAGONALE INTERNE
12	948209 00000	BAGUE DE SURETE
14	906595 00000	BAGUE D'ETANCHEITE
17	912871 00000	BOUCHON
18	000800 26600	COUVERCLE
19	000700 26600	COUVERCLE
20	951211 00000	BOUCHON
21	948744 00000	GOUPILLE CYLINDRIQUE
22	945390 00000	VIS HEXAGONALE INTERNE
24	005600 26600	COUVERCLE
29	029100 26600	SUPPORT DE SOUPAPE
30	033904 26600	CLAPET
33	928603 10000	RESSORT DE PRESSION
34	007800 26600	BRIDE
35	948225 00000	BAGUE DE SURETE
36	008000 26600	FILTRE
37	945351 00000	VIS HEXAGONALE INTERNE
38	946967 00000	TOURILLON
39	003700 26600	COUVERCLE
42	947410 00000	ECROU BORGNE
43	951604 00000	ECROU A ANNEAU
44	947514 00000	RONDELLE
72	002400 26600	CARCASSE POUR SEPARATION D'HUILE
74	022800 26600	SUPPORT FILTRE
76	951049 02000	TOURILLON
77	033901 26600	CLAPET
78	030700 26600	DISQUE DE SOUPAPE
79	917551 04000	DISQUE DE TOLERANCE
80	948128 04000	BAGUE DE SURETE
81	928602 80000	RESSORT DE PRESSION
82	950185 00000	BAGUE DE SURETE
83	005603 26600	COUVERCLE
84	945637 00000	GOUPILLE FILETEE
85	068005 26600	PIECE D'ECARTEMENT
89	965410 00000	ELEMENT SEPARATION HUILE (2x) ²⁾
90	068008 26600	PIECE D'ECARTEMENT
92	951041 02000	TOURILLON
94	506000 12900	SEPARATEUR A GROS (3x) ²⁾
95	030701 10700	RONDELLE
97	947402 00000	ECROU BORGNE
100	002504 26600	COUVERCLE SEPARATEUR D'HUILE
102	945391 00000	VIS HEXAGONALE INTERNE
103	945392 00000	VIS HEXAGONALE INTERNE
105	002500 26600	COUVERCLE DU SEPARATEUR D'HUILE
107	945353 00000	VIS HEXAGONALE INTERNE
108	945350 00000	VIS HEXAGONALE INTERNE
110	008003 26600	TAMIS
112	867800 99559	PIED CAOUTCHOVE
113	912300 00000	VIS DE RACCORD
115	003300 10700	GICLEUR
117	002501 26600	COUVERCLE DU SEPARATEUR D'HUILE
122	907309 00000	VERRE REGARD
123	951220 00100	BOUCHON
126	916800 10000	COUVERCLE
131	946945 00000	PRISONNIER
133	951221 00100	BOUCHON
137	064600 26600	FILTRE DE RECHANGE
138	008002 26600	FILTRE
144	068006 26600	PIECE D'ECARTEMENT
145	948215 00000	BAGUE DE SURETE
146	928603 30000	RESSORT DE PRESSION
151	502301 26600	ACCOUPEMENT AVEC VENTILATEUR
175	948401 00000	VIS CREUSE



U 4.400

Pos.	No. Identification	Designation
176	048400 26600	VIS CREUSE
177	945224 00000	VIS HEXAGONALE
178	030701 26600	TETE DE SOUPAPE
179	030702 26600	TETE DE SOUPAPE
180	016801 26600	DISQUE DE SERRAGE
182	928603 20000	RESSORT DE PRESSION
183	016800 26600	DISQUE DE SERRAGE
184	028500 26600	TIGE DE SOUPAPE
186	947104 00000	ECROU A 6 PANS
187	013300 26600	FILTRE METALIQUE
188	945330 00000	VIS HEXAGONALE INTERNE
189	947506 00000	RONDELLE
192	947107 00000	ECROU A 6 PANS
194	948516 00000	ANNEAU RESSORT
197	947820 00000	CLAVETTE
198	062900 26600	RONDELLE
202	053200 26600	BRIDE DE RACCORDEMENT
203	945388 00000	VIS HEXAGONALE INTERNE
204	947515 00000	RONDELLE
205	948511 00000	ANNEAU RESSORT
208	003702 26600	COUVERCLE
211	003701 26600	COUVERCLE
212	945333 00000	VIS HEXAGONALE INTERNE
215	741341 00000	AMORTISSEUR EN CAOUTCHOUC
216	945633 00000	GOUPILLE FILETEE
217	068001 26600	DONILLE D'ECARMENT
218	946811 00000	TOURILLON
222	560200 26600	REFROIDISSEUR
223	945349 00000	VIS HEXAGONALE INTERNE
224	951710 00000	DISQUE DE RESSORT
227	902102 26600	ACCOUPEMENT MOTEUR
228	902227 00000	DISQUE D'ACCOUPEMENT
229	068004 26600	PIECE D'ECARTEMENT
231	946962 00000	TOURILLON
233	947109 00000	ECROU A 6 PANS
234	947509 00000	RONDELLE
236	961710 00000	COUDES
237	972308 00000	RACCORD A VIS
238	512204 26600	TUYAU D'HUILE
239	512200 26600	TUYAU D'HUILE
241	012204 26700	TUYAU
243	761703 01000	RACCORD A VIS
244	012206 26600	TUYAU
245	012207 26600	TUYAU
247	961709 00000	COUDES
248	064101 57000	CAOUTCHOUC PROFILE
251	009400 19000	VIS CREUSE DE FIXATION
255	518300 26600	CARTER PROTECTEUR
256	945389 00000	VIS HEXAGONALE INTERNE
290	060900 26600	AMORTISSEUR
291	943400 90000	PALPEUR DE TEMPERATURE

¹⁾ Jeu de joints - 549000 26700

- Pos.: 15, 16, 25, 31, 32, 40, 73, 87, 88, 101, 106, 109, 118, 124, 127, 135, 141, 185, 191, 242, 246, 252, 254

²⁾ quantité nécessaire / entretien

EN OPTION

- U 4.400 SA/K -25** Exécution spéciale – avec réfrigérant à l'huile et à l'eau
- U 4.400 SA/K -51** Exécution spéciale – avec chauffage du bain d'huile, capteur de niveau et thermostat
- U 4.400 F/K -25** Exécution spéciale – avec réfrigérant à l'huile et à l'eau
- U 4.400 F/K -51** Exécution spéciale – avec chauffage du bain d'huile, capteur de niveau et thermostat
- U 4.400 USA** Tous les exécution

Articles divergents vis-à-vis de l'appareil standard, voir annexe (dos du dessin / du plan)





U 4.400

Pos.	No. Identificazione	Designazione
□	549000 26700	SERIE COMPLETA DI GUARNIZIONE ¹⁾
2	000100 26600	CARCASSA
3	020000 26600	ROTORE
4	951212 00000	TAPPO A VITE
6	900580 00003	PALETTA IN PLASTICA (KIT)
7	030703 26600	RONDELLA
8	906617 50000	CUSCINETTO
9	906600 00700	ANELLO INTERNO
10	906600 00800	ANELLO INTERNO
11	945331 00000	VITE ESAGONALE INTERNA
12	948209 00000	ANELLO DI SICUREZZA
14	906595 00000	ANELLO DI TENUTA
17	912871 00000	VITE DI CHIUSURA
18	000800 26600	COPERCHIO
19	000700 26600	COPERCHIO
20	951211 00000	TAPPO A VITE
21	948744 00000	PERNO
22	945390 00000	VITE ESAGONALE INTERNA
24	005600 26600	COPERCHIO
29	029100 26600	SEDE DELLA VALVOLA
30	033904 26600	SUPPORTO VALVOLA
33	928603 10000	MOLLA DELLA PRESSIONE
34	007800 26600	FLANGIA
35	948225 00000	ANELLO DI SICUREZZA
36	008000 26600	FILTRO
37	945351 00000	VITE ESAGONALE INTERNA
38	946967 00000	L'ASTA A VITE
39	003700 26600	COPERCHIO
42	947410 00000	DADO CIECO
43	951604 00000	GOLFARE CON FORO FILETTATO
44	947514 00000	RONDELLA
72	002400 26600	CARCASSE SEPARAZIONE OLIO
74	022800 26600	SUPPORTO FILTRO
76	951049 02000	L'ASTA A VITE
77	033901 26600	SUPPORTO VALVOLA
78	030700 26600	DISCO DELLA VALVOLA
79	917551 04000	DISCO A DISTANZA
80	948128 04000	ANELLO DI SICUREZZA
81	928602 80000	MOLLA DELLA PRESSIONE
82	950185 00000	ANELLO DI SICUREZZA
83	005603 26600	COPERCHIO
84	945637 00000	SPINA FILETTATURA
85	068005 26600	DISTANZIATORE
89	965410 00000	CARTUCCIA SEPARATORE OLIO (2x) ²⁾
90	068008 26600	DISTANZIATORE
92	951041 02000	L'ASTA A VITE
94	506000 12900	SEPARATORE GROSSOLANO (3x) ²⁾
95	030701 10700	RONDELLA
97	947402 00000	DADO CIECO
100	002504 26600	COPERCHIO SEPARATOR OLIO
102	945391 00000	VITE ESAGONALE INTERNA
103	945392 00000	VITE ESAGONALE INTERNA
105	002500 26600	COPERCHIO SEPARATORE OLIO
107	945353 00000	VITE ESAGONALE INTERNA
108	945350 00000	VITE ESAGONALE INTERNA
110	008003 26600	STACCIO
112	867800 99559	GALLEGGIANTE
113	912300 00000	ATTACO FILETTATO
115	003300 10700	UGELLO
117	002501 26600	COPERCHIO SEPARATORE OLIO
122	907309 00000	SPIA LIVELLO OLIO
123	951220 00100	VITE DI CHIUSURA
126	916800 10000	COPERCHIO
131	946945 00000	L'ASTA A VITE
133	951221 00100	VITE DI CHIUSURA
137	064600 26600	FILTRO DI RICAMBIO
138	008002 26600	FILTRO
144	068006 26600	DISTANZIATORE
145	948215 00000	ANELLO DI SICUREZZA
146	928603 30000	MOLLA DELLA PRESSIONE
151	502301 26600	GIUNTO CON VENTILATORE
175	948401 00000	VITE CAVA



U 4.400

Pos.	No. Identificazione	Designazione
176	048400 26600	VITE CAVA
177	945224 00000	VITE ESAGONALE
178	030701 26600	DISCO DELLA VALVOLA
179	030702 26600	DISCO DELLA VALVOLA
180	016801 26600	DISCO DI FISSAGGIO
182	928603 20000	MOLLA DELLA PRESSIONE
183	016800 26600	DISCO DI FISSAGGIO
184	028500 26600	VALVOLA BULLONE
186	947104 00000	DADO ESAGONALE
187	013300 26600	FILTRO METALICO
188	945330 00000	VITE ESAGONALE INTERNA
189	947506 00000	RONDELLA
192	947107 00000	DADO ESAGONALE
194	948516 00000	RONDELLA GROWER
197	947820 00000	CHIAVETTA
198	062900 26600	RONDELLA
202	053200 26600	FLANGIA DI RACCORDE
203	945388 00000	VITE ESAGONALE INTERNA
204	947515 00000	RONDELLA PIANA
205	948511 00000	RONDELLA GROWER
208	003702 26600	COPERCHIO
211	003701 26600	COPERCHIO
212	945333 00000	VITE ESAGONALE INTERNA
215	741341 00000	AMMORTIZZATORE IN GOMMA
216	945633 00000	VITE SENZA TESTA
217	068001 26600	BOCCOLA DISTANZIATRICE
218	946811 00000	VITE PRIGIONIERA
222	560200 26600	RAFFREDDATORE
223	945349 00000	VITE ESAGONALE INTERNA
224	951710 00000	DISCO A MOLLA
227	902102 26600	GIUNTO MOTORE
228	902227 00000	DISCO GIUNTO
229	068004 26600	BOCCOLA DISTANZIATRICE
231	946962 00000	VITE PRIGIONIERA
233	947109 00000	DADO ESAGONALE
234	947509 00000	RONDELLA PIANA
236	961710 00000	GOMITO
237	972308 00000	RACCORDO A VITE
238	512204 26600	CONDOTTO OLIO
239	512200 26600	CONDOTTO OLIO
241	012204 26700	CONDOTTO
243	761703 01000	RACCORDO A VITE
244	012206 26600	CONDOTTO
245	012207 26600	CONDOTTO
247	961709 00000	GOMITO
248	064101 57000	GOMMA PROFILATO
251	009400 19000	VITE PASSAGGIO OLIO
255	518300 26600	CARTER DI PROTEZIONE
256	945389 00000	VITE ESAGONALE INTERNA
290	060900 26600	SILENZIATORE
291	943400 90000	PALPATORE DI TEMPERATURA

¹⁾ Serie di guarnizione - 549000 26700

- Pos.: 15, 16, 25, 31, 32, 40, 73, 87, 88, 101, 106, 109, 118, 124, 127, 135, 141, 185, 191, 242, 246, 252, 254

²⁾ quantità di ordinazione necessari / manutenzione

OPZIONALE

U 4.400 SA/K	-25	Modello speciale - con radiatore ad olio - acqua
U 4.400 SA/K	-51	Modello speciale - con riscaldamento a bagno d'olio, indicatore di livello e termostato
U 4.400 F/K	-25	Modello speciale - con radiatore ad olio - acqua
U 4.400 F/K	-51	Modello speciale - con riscaldamento a bagno d'olio, indicatore di livello e termostato
U 4.400	USA	Tutte tipi

Vedere allegato (retro del disegno) per le posizioni divergenti dall'apparecchio standard



Pos.	No. De pedido	Descripción
□	549000 26700	JUEGO DE JUNTA ¹⁾
2	000100 26600	CARCASA
3	020000 26600	ÉMBOLO
4	951212 00000	TORNILLO DE CIERRE
6	900580 00003	DESPLAZADOR DE PLÁSTICO (KIT)
7	030703 26600	ARANDELA
8	906617 50000	COJINETE DE RODAMIENTO
9	906600 00700	ANILLO INTERIOR
10	906600 00800	ANILLO INTERIOR
11	945331 00000	TORNILLO HEXAGONAL INTERIOR
12	948209 00000	ANILLO DE RETENCIÓN
14	906595 00000	ANILLO DE JUNTA DE ÁRBOL
17	912871 00000	TORNILLO DE CIERRE
18	000800 26600	TAPA LATERAL
19	000700 26600	TAPA LATERAL
20	951211 00000	TORNILLO DE CIERRE
21	948744 00000	PASADOR CILINDRICO ESTRIADO
22	945390 00000	TORNILLO HEXAGONAL INTERIOR
24	005600 26600	TAPA
29	029100 26600	SOPORTE DE VÁLVULA
30	033904 26600	PLACA DE VÁLVULA
33	928603 10000	MUELLE DE COMPRESIÓN
34	007800 26600	BRIDA ROSCADA
35	948225 00000	ANILLO DE ASEGURAMIENTO
36	008000 26600	CRIBA
37	945351 00000	TORNILLO HEXAGONAL INTERIOR
38	946967 00000	ESPÁRRAGO
39	003700 26600	TAPA
42	947410 00000	TUERCA DE CAPERUZA
43	951604 00000	TUERCA DE CÁNCAMO
44	947514 00000	ARANDELA
72	002400 26600	CARCASA DE SEPARADOR DE ACEITE
74	022800 26600	SOPORTE DE FILTRO
76	951049 02000	ESPÁRRAGO
77	033901 26600	PLACA DE VÁLVULA
78	030700 26600	DISCO DE VÁLVULA
79	917551 04000	ARANDELA DE AJUSTE
80	948128 04000	ANILLO DE RETENCIÓN
81	928602 80000	MUELLE DE COMPRESIÓN
82	950185 00000	ABRAZADERA DE APRIETE
83	005603 26600	TAPA
84	945637 00000	VARILLA ROSCADA
85	068005 26600	PIEZA DISTANCIADORA
89	965410 00000	ELEMENTO DE DESACEITAR DE AIRE (2x) ²⁾
90	068008 26600	PIEZA DISTANCIADORA
92	951041 02000	ESPÁRRAGO
94	506000 12900	SEPARADOR DE SÓLIDOS GRUESOS (3x) ²⁾
95	030701 10700	ARANDELA
97	947402 00000	TUERCA CIEGA
100	002504 26600	TAPA DE SEPARADOR DE ACEITE
102	945391 00000	TORNILLO HEXAGONAL INTERIOR
103	945392 00000	TORNILLO HEXAGONAL INTERIOR
105	002500 26600	TAPA DE SEPARADOR DE ACEITE
107	945353 00000	TORNILLO HEXAGONAL INTERIOR
108	945350 00000	TORNILLO HEXAGONAL INTERIOR
110	008003 26600	CRIBA
112	867800 99559	FLOTADOR
113	912300 00000	TORNILLO DE EMPALME
115	003300 10700	TOBERA
117	002501 26600	TAPA DE SEPARADOR DE ACEITE
122	907309 00000	CRISTAL MIRILLA DE ACEITE
123	951220 00100	TORNILLO DE CIERRE
126	916800 10000	TAPA ROSCADA
131	946945 00000	ESPÁRRAGO
133	951221 00100	TORNILLO DE CIERRE
137	064600 26600	ESTERA DE FILTRO
138	008002 26600	CRIBA
144	068006 26600	PIEZA DISTANCIADORA
145	948215 00000	ANILLO DE RETENCIÓN
146	928603 30000	MUELLE DE COMPRESIÓN
151	502301 26600	MITAD DE ACOPLAMIENTO CON VENTILADOR
175	948401 00000	TORNILLO HUECO

Pos.	No. De pedido	Descripción
176	048400 26600	TORNILLO HUECO
177	945224 00000	TORNILLO DE CABEZA HEXAGONAL
178	030701 26600	DISCO DE VÁLVULA
179	030702 26600	DISCO DE VÁLVULA
180	016801 26600	ARANDELA TENSORA
182	928603 20000	MUELLE DE COMPRESIÓN
183	016800 26600	ARANDELA TENSORA
184	028500 26600	BULÓN DE VÁLVULA
186	947104 00000	TUERCA HEXAGONAL
187	013300 26600	CHAPA DE REBOTE
188	945330 00000	TORNILLO HEXAGONAL INTERIOR
189	947506 00000	ARANDELA
192	947107 00000	TUERCA HEXAGONAL
194	948516 00000	ARANDELA DE MUELLE
197	947820 00000	LENGÜETA DE AJUSTE
198	062900 26600	ARANDELA
202	053200 26600	FAROL
203	945388 00000	TORNILLO HEXAGONAL INTERIOR
204	947515 00000	ARANDELA
205	948511 00000	ARANDELA DE MUELLE
208	003702 26600	TAPA
211	003701 26600	TAPA
212	945333 00000	TORNILLO HEXAGONAL INTERIOR
215	741341 00000	AMORTIGUADOR DE GOMA
216	945633 00000	VARILLA ROSCADA
217	068001 26600	PIEZA DISTANCIADORA
218	946811 00000	ESPÁRRAGO
222	560200 26600	REFRIGERADOR COMPLETO
223	945349 00000	TORNILLO HEXAGONAL INTERIOR
224	951710 00000	ARANDELA ELÁSTICA
227	902102 26600	ACOPAMIENTO DE MOTOR
228	902227 00000	DISCO DE ACOPLAMIENTO
229	068004 26600	PIEZA DISTANCIADORA
231	946962 00000	ESPÁRRAGO
233	947109 00000	TUERCA HEXAGONAL
234	947509 00000	ARANDELA
236	961710 00000	ÁNGULO
237	972308 00000	ATORNILLADURA ERMETO
238	512204 26600	CONDUCTO
239	512200 26600	CONDUCTO DE RETROALIMENTACIÓN DE ACEITE
241	012204 26700	CONDUCTO
243	761703 01000	ATORNILLADURA ERMETO
244	012206 26600	CONDUCTO
245	012207 26600	CONDUCTO
247	961709 00000	ÁNGULO
248	064101 57000	GOMA PERFILADA
251	009400 19000	TORNILLO DE PIEZA ESFÉRICA
255	518300 26600	CAPERUZA
256	945389 00000	TORNILLO HEXAGONAL INTERIOR
290	060900 26600	ESTERA DE AMORTIGUADOR
291	943400 90000	SENSOR DE TEMPERATURA

¹⁾ Junta completa - 549000 26700

- Pos.: 15, 16, 25, 31, 32, 40, 73, 87, 88, 101, 106, 109, 118, 124, 127, 135, 141, 185, 191, 242, 246, 252, 254

²⁾ cantidad necesario / mantenimiento

OPCIONAL

U 4.400 SA/K -25	Versión especial – con refrigerador aceite-agua
U 4.400 SA/K -51	Versión especial – con calefacción de baño de aceite, codificador de nivel y termostato
U 4.400 F/K -25	Versión especial – con refrigerador aceite-agua
U 4.400 F/K -51	Versión especial – con calefacción de baño de aceite, codificador de nivel y termostato
U 4.400 USA	Versión general

Para posiciones que derivan del aparato standard véase apéndice (lado trasero del plano) 

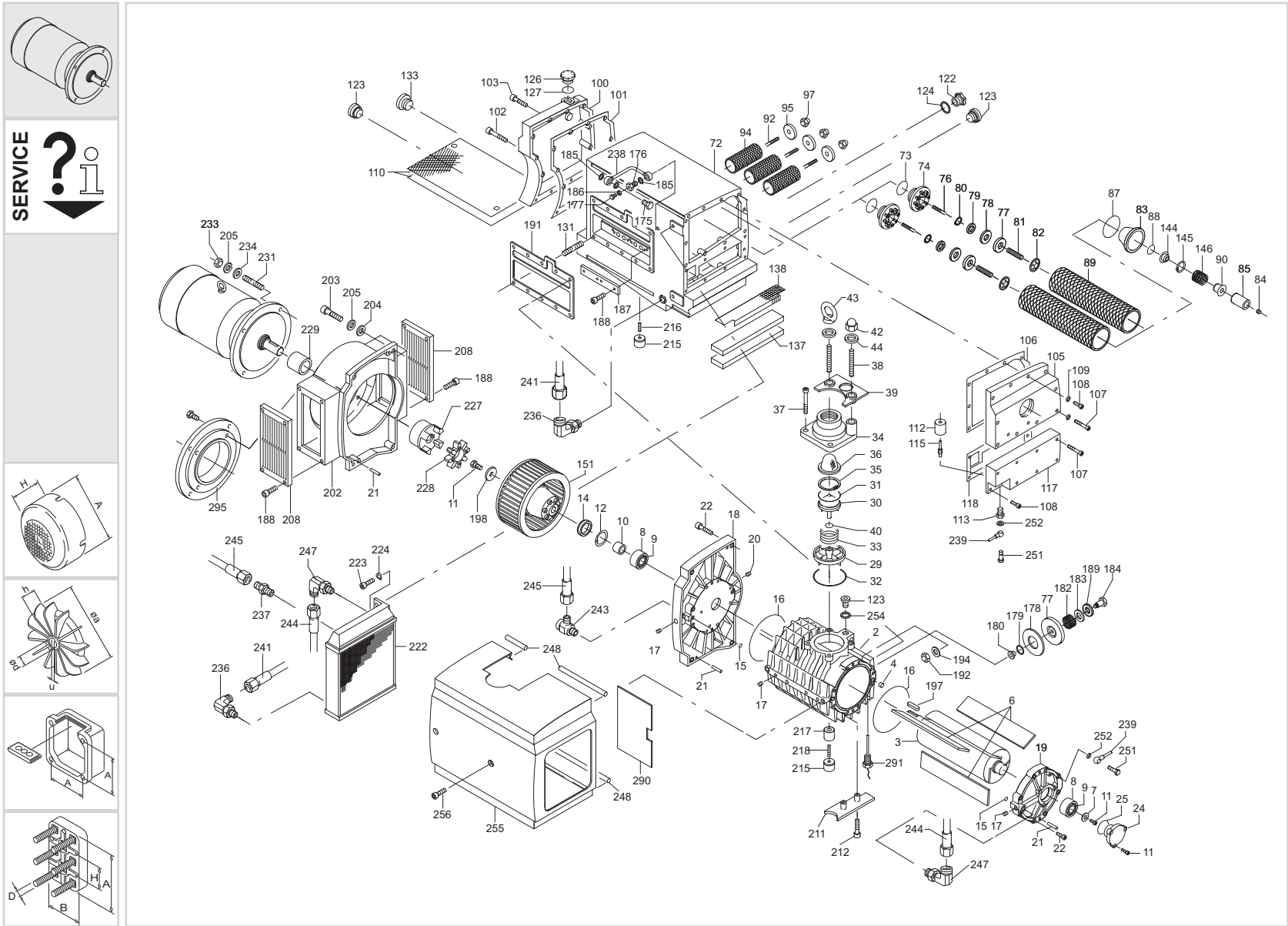

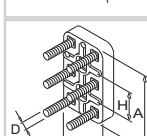
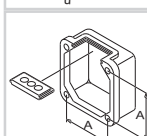
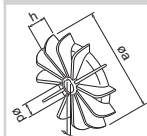
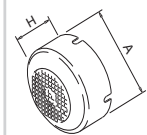

SERVICE ?



standard

U 4.400 F/K
U 4.400 SA/K

optional
en option
opcionale
opcional

optional en option optionale opcional 	Variante(n) Modifications Variantes	Pos ³⁾	Bestell Nr. / Ident No. / No. Identification / No. Identificazione / No. De pedido		Beschreibung / Description / Designation / Designazione / Desripcion
					
U 4.400 SA/K-XX U 4.400 F/K-XX	U 4.400 (USA) (all variants, plus auxiliarys)	34	007801 26600	007800-26600	GEWINDEFLENSCH / FLANGE / BRIDE / FLANGIA / BRIDA ROSCADA ÖLABSCHEIDERDECKEL / OIL SEPARATOR COVER / COUVERCLE DE SEPARATEUR D'HUILE / COPERCHIO SEPARAZIONE OLIO / TAPA DE SEPARADOR DE ACEITE MOTORKUPPLUNG / COUPLING MOTORSIDE / ACCOUPLEMENT MOTEUR / GUINTO MOTORE / ACOPLAMIENTO DE MOTOR Distanzstück / Spacer block / Piece d'ecartement / Distanziatore / Pieza distanciadora U-Scheibe / Washer / Rondele / Rondella / Arandela Zwischenflansch / Flange / Bride / Flangia / Brida intermedia
		105	002503 26600	002500-26600	
		227	902103 26600	902102-26600	
		229	068093 26600	068004-26600	
		234		947509-00000	
	295	037900 26700			
	U 4.400 SA/K-25 U 4.400 F/K-25	72	002401 26600	002400-26600	ÖLABSCHEIDERGEHÄUSE / HOUSING FOR OIL SEPARATION / CORP DE SEPARATEUR D'HUILE / CARCASSA SEPARAZIONE OLIO / CARCASA DE SEPARADOR DE ACEITE Zwischenstück / Intermediate piece / Bride / Flange / Pieza intermedia Kühler / Cooler / Refroidisseur / Raffreddatore / Refrigerador Kupferring / Sealing ring / Joint / Anello / Anillo de cobre
		116	012400 26600		
		121	560202 26600		
	125	948029 00000			
U 4.400 SA/K-51 U 4.400 F/K-51	72	002401 26600	002400-26600	ÖLABSCHEIDERGEHÄUSE / HOUSING FOR OIL SEPARATION / CORP DE SEPARATEUR D'HUILE / CARCASSA SEPARAZIONE OLIO / CARCASA DE SEPARADOR DE ACEITE ROHRHEIZKÖRPER / PIPE HEATER / CORPS DE CHAUFFE / SCALDIGLIA / CALEFACTOR TUBULAR Temperaturwächter / Thermostat / Thermostat / Interruttore termico / Termostato Reduzier-Nippel / Reducing bushes / Mamelons reduits / raccordo di riduzione / Boquilla de reducción Verschluss-Schraube / Screw plug / Bouchon / vite di chiusura / Tornillo de cierre Niveaugeber / Level transmitter / Capteur de niveau / Indicatore di livello / Codificador de nivel	
	121	560201 26600			
	129	943400 70000			
	130	300300 07000			
	133		951221-00000		
134	741103 99682				

³⁾ variantenabhängige Bauteile / variant-dependent components / composants variante-dependantes / componenti variante-dispendenti / componentes variante-dependientes

 standard